



WHO WE ARE:

VINPROM ENERGETIKA d.o.o.

Šmartinska 129/a

1000 Ljubljana, Slovenia (EU)



Based from 1993 in the field of energetic and absorption

Plant:

Neža 47

Trbovlje. Slovenia (EU)

Office:

Ljubljana, Slovenia (EU)

We are Manufacturers of the equipment on energetic field and technology according our own design. What ever we are producing is designed by us and shall be in accordance with the demands for known Customer. Our Scope of Supply is:

- **Design of the Plant and Construction the equipment**
- **Manufacturing the equipment**
- **Start – up of the equipment**

80% export Europe, USA, S. Africa, Near and Middle East

WE ARE THE MOST ACTIVE:



Absorption chilling technology / production of Absorption Liquid Chillers for CARRIER

Co-generation and three-generation systems for simultaneous heat, cold and power production



Spiral, tube and tube-shell heat exchangers



Heating & cooling stations and cooling systems in process industry of rubber, polyurethanes, and basic chemistry

Pressure vessels, storage tanks for hazardous compounds and other equipment used in process industry, biomass boiler units



WE OFFER:



New ideas and project solution

Project documentation

Own production of equipment

Start up of equipment

Certificate

Quality, innovations and functionality

Customer needs

A promise made to the customer

Supported with expert knowledge and experiences

Constant development

Customers and suppliers are our assurance for success



CERTIFICATES:

Company certificates (TUV, ISO 3834-3, DIN EN 729-3, HP-0 TRD EN, AD 2000-Merkblatt HP0- HP 100R TRD 201,...)

Welders certificates

Engineers certificates EWE, IZS,...

Equipment Certificates TÜV Rheinland CE 0035,

TÜV SUD CE 0036

Welding Procedure Quality Report WPQR



VINPROM PRODUCT RANGE



Pictures and technical data



SINGLE EFFECT ABSORPTION CHILLER AHS

Using waste heat / energy for Cooling:

Hot water 75 oC 150 oC Single Effect Chiller COP ~ 0,7

Low pressure steam < 1 barg Single Effect Chiller COP ~ 0,7

Cooling effect 150 to 2400 kW nominal capacity

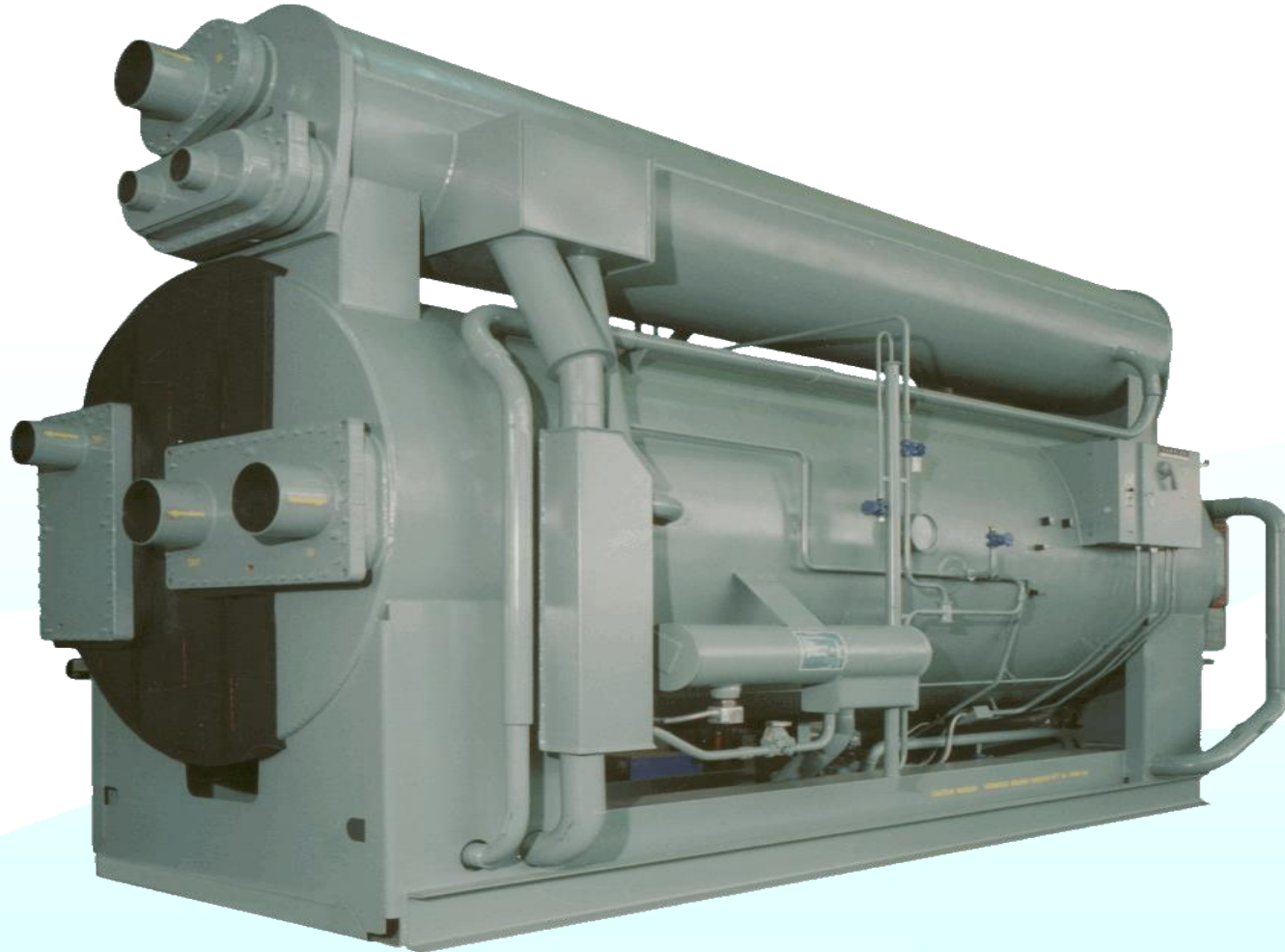

CONTAINER VERSION



COMPACT HEATING, PUMPING STATION

Using: proces heating, temperature control, flow control ...



HEAT EXCHANGER WITH SPIRAL TUBE

Using: heating- district heating, preparing sanitary heat water, steam condenser



HEAT EXCHANGER TUBE&SHELL

Using: for heating water, oil, chemical solutions or other medium with water or steam; condenser, condensate sub-cooler, compress air cooler or gas cooler ,...

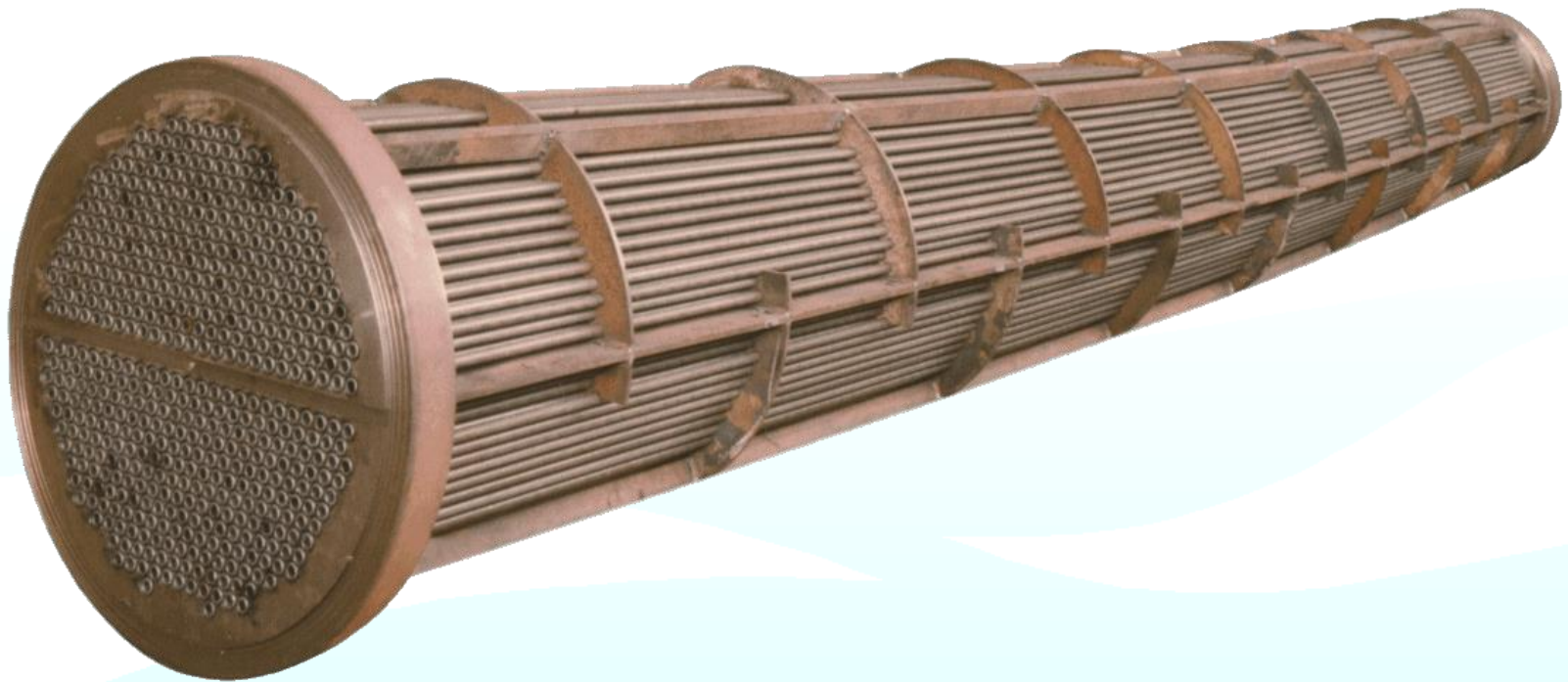

U – TUBE HEAT EXCHANGER



STEAM EXPANDER

Using: Transforming hot condensate to saturated steam



ELECTRIC HEATERS



ELECTRIC HEATERS FOR THERMAL OIL



HEATER FOR SANITARY WATER

Lloyd register Certificate for shipping industry

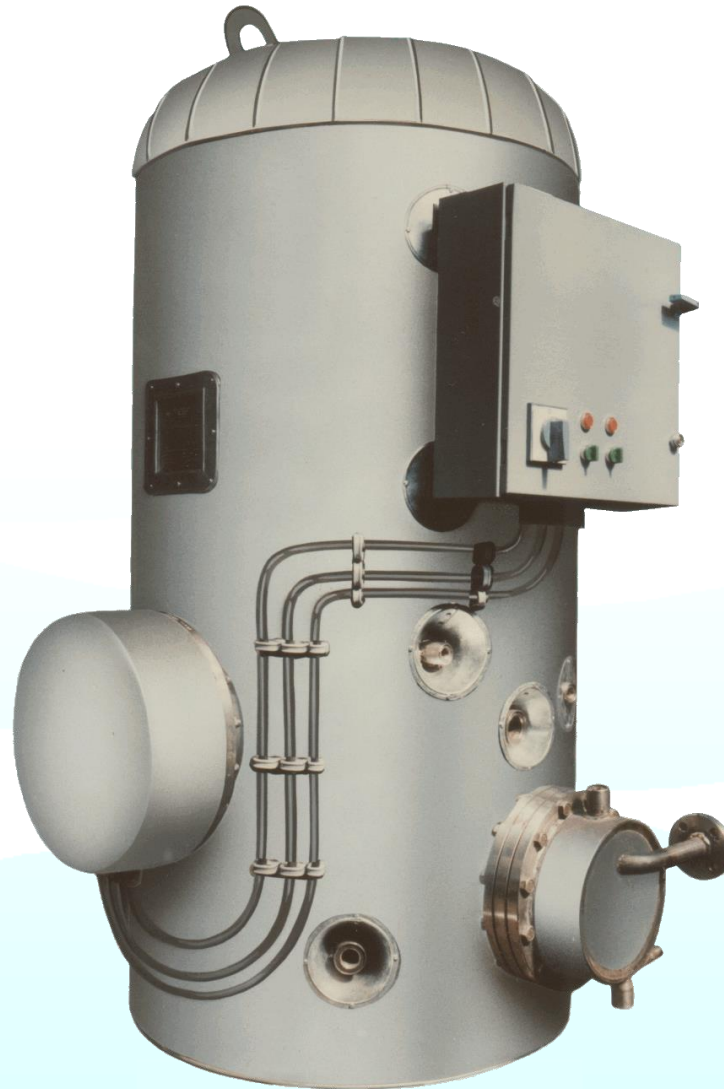

WATER FEEDING TANK WITH DEGASATION UNIT

Using: for steam boiler plants



STRAINERS FOR FILTERING LIQUID AND GAS MEDIUM

Screen: 500 μm up to 10 μm

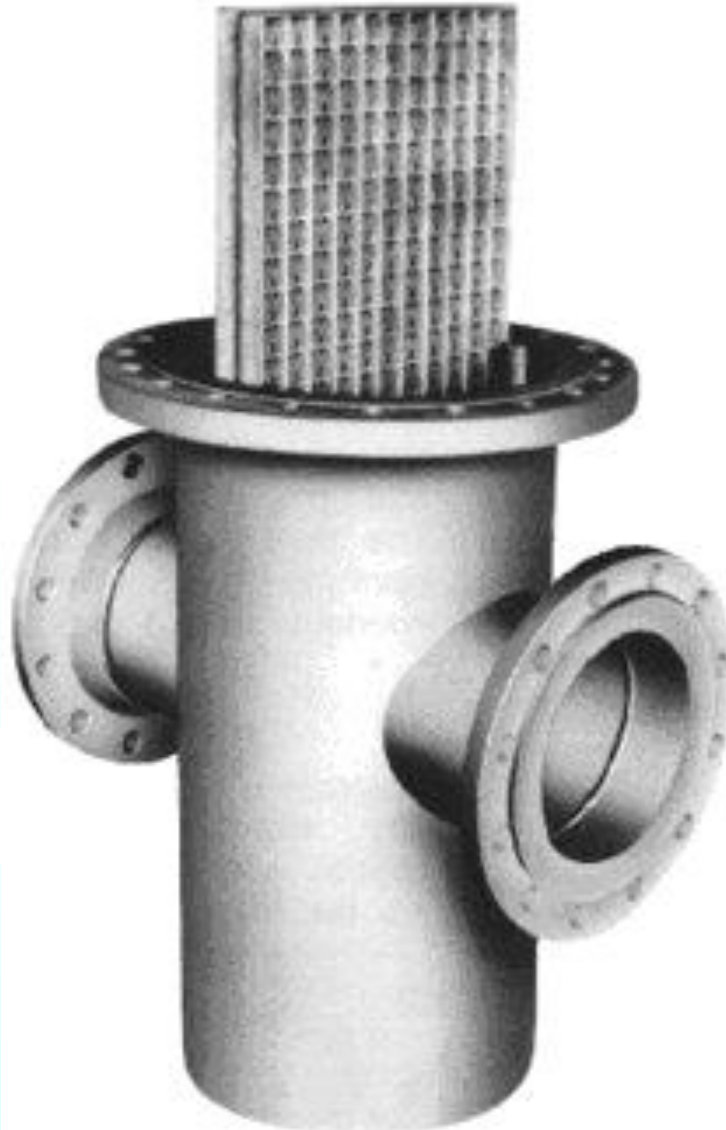

GAS PRE-HEATER AND GAS EVAPORATOR

Up to 60 bar operating pressure

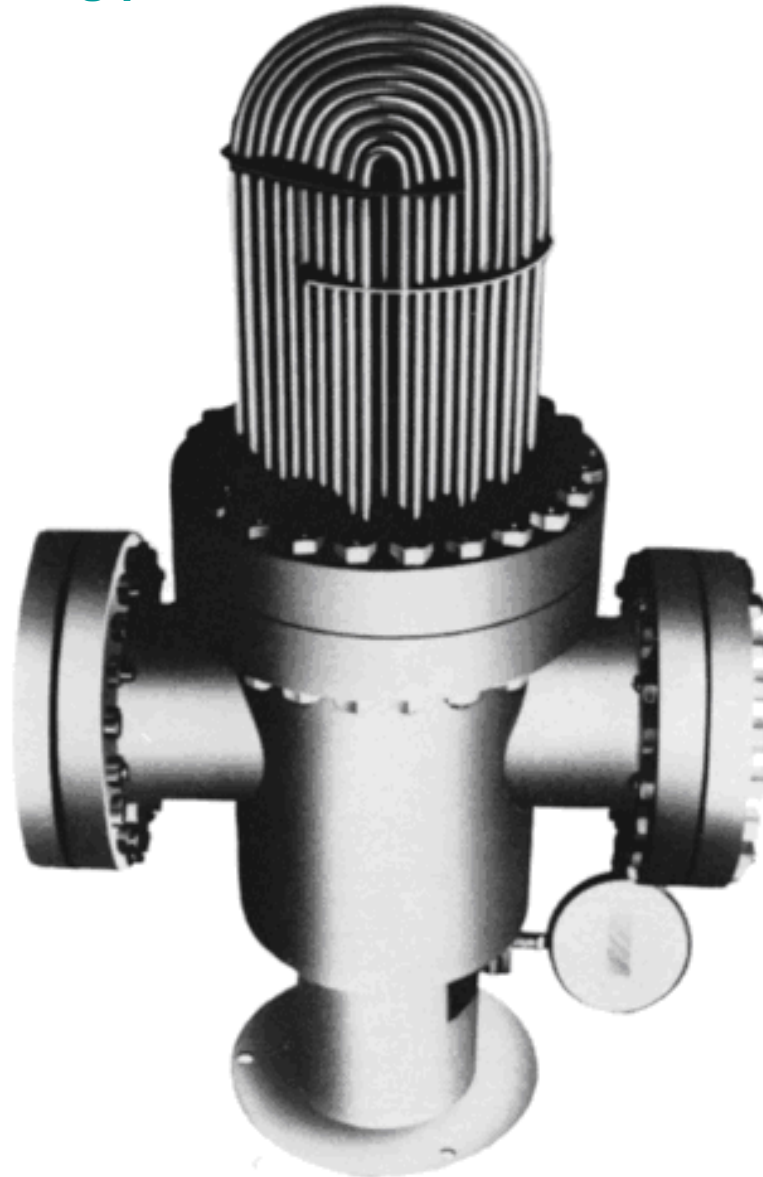

HOT WATER AND STEAM BOILERS

From 500 kW to 12000 kW



GAS WATER HEATERS



Procesni Inženiring – Colarič
&



SOME REFERENCES

Biomass plants:

- KWK Schwarzau Austria
- Vargarda Sweden
- CTA Singapore
- Santa Catarina Italy
- Fabrika ulja Banat Zrenjanin Serbia
- Merkscha Celje Slovenia

Co-generation plants:

- Georgia pacific Paper Mill Oregon USA
- Sheraton Hotel Pakistan
- Airport Munich Germany
- Commerz Bank Frankfurt Germany
- Coca Cola Hungary
- Human - TEWA Hungary
- Hospital St. Polten, Klinikum Linz Austria
- Tungsram Hungary
- Lek Farmaceutical Slovenia
- TUŠ Shopping Centre Slovenia

Pressur and process equipment:

- FB Silbermann Germany
- Alder Italy
- Lafarge Karsdorf Germany
- Wietersdorf Peggau Austria
- Goodyear Slovenia
- Acroni Slovenia
- Cinkarna Slovenia





SOME PROJECT REFERENCES

ABSORPTION LIQUID CHILLER STATION

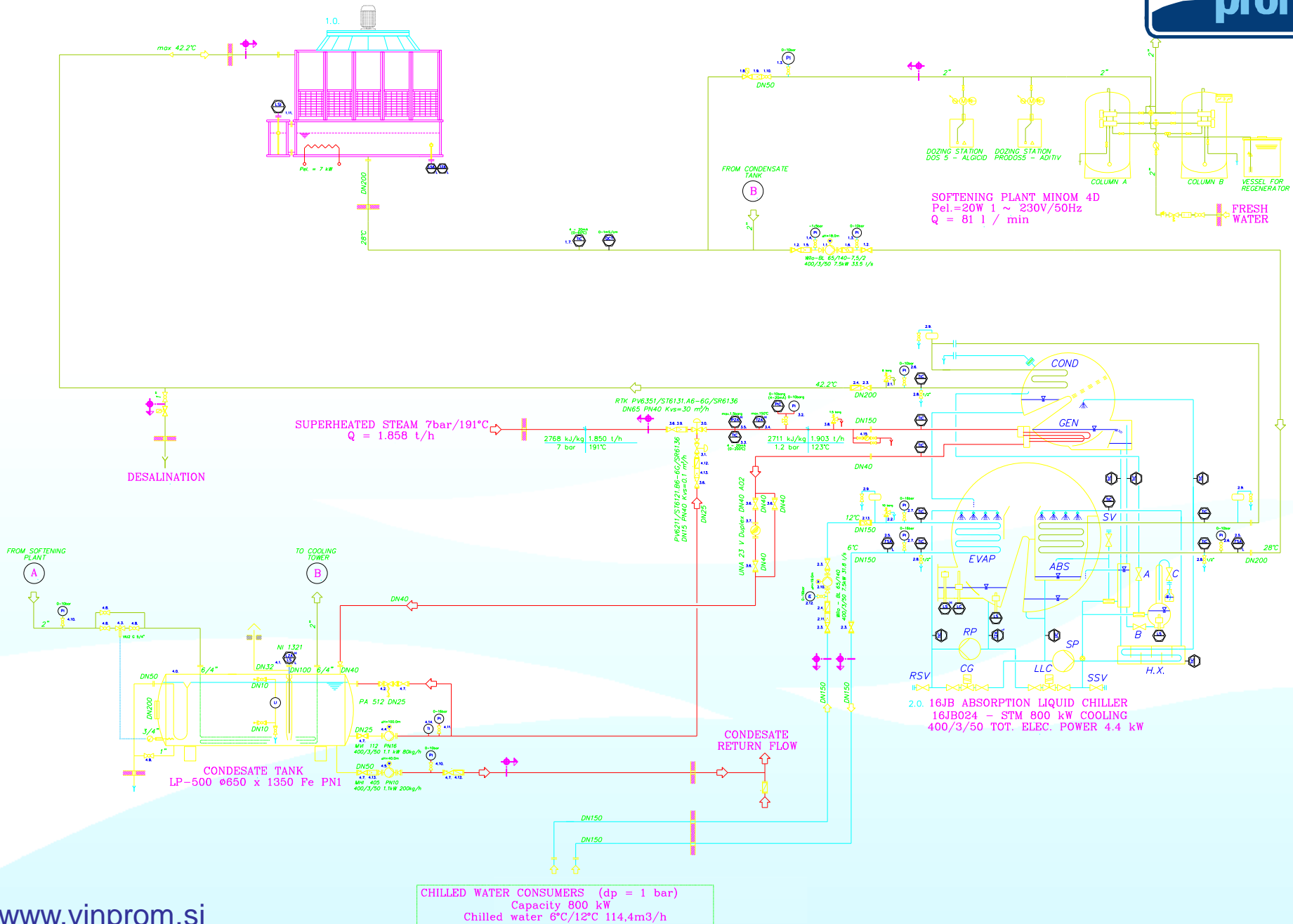

CONTAINER EXECUTION OUTLOOK

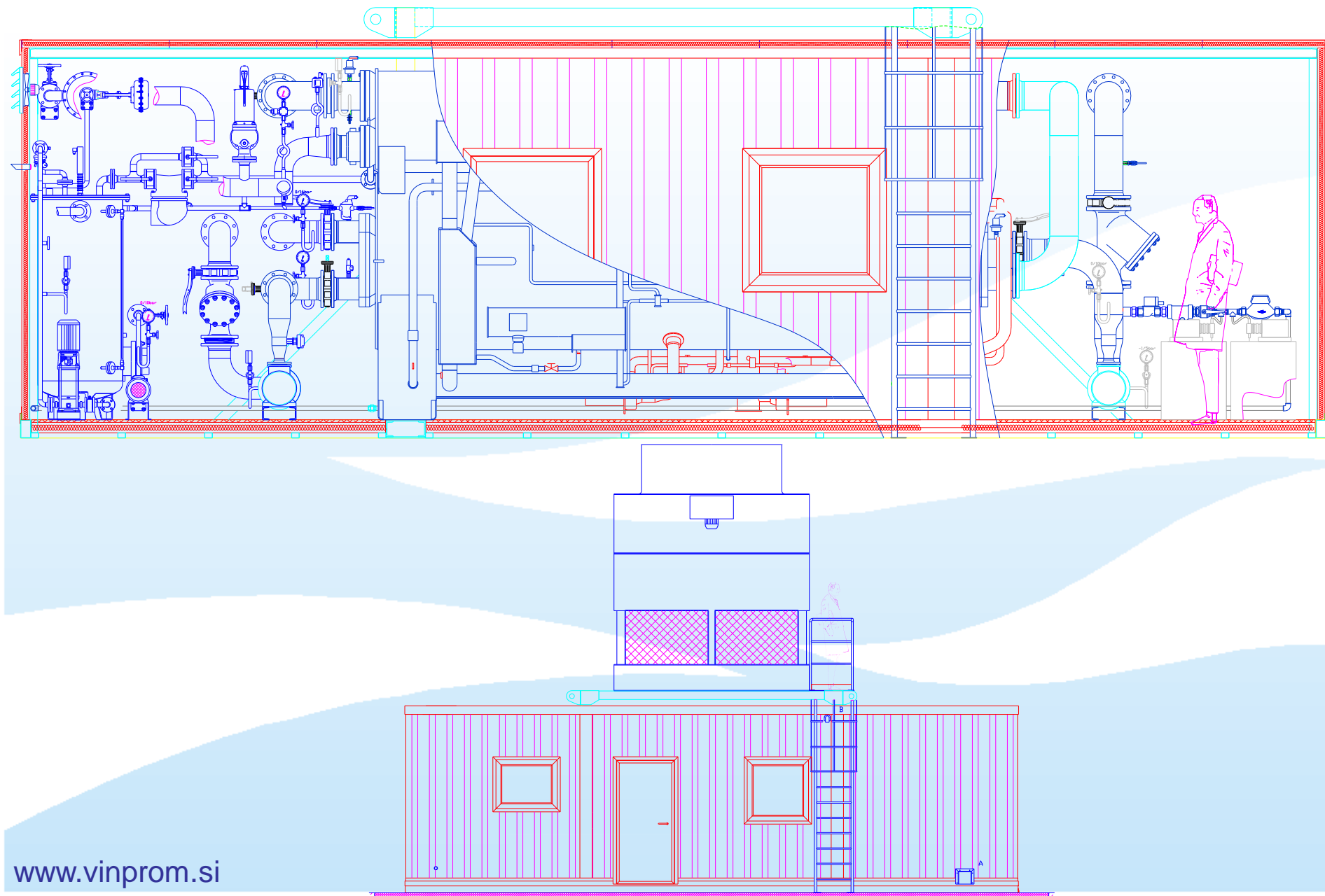

TECHNOLOGY COOLING COCA COLA

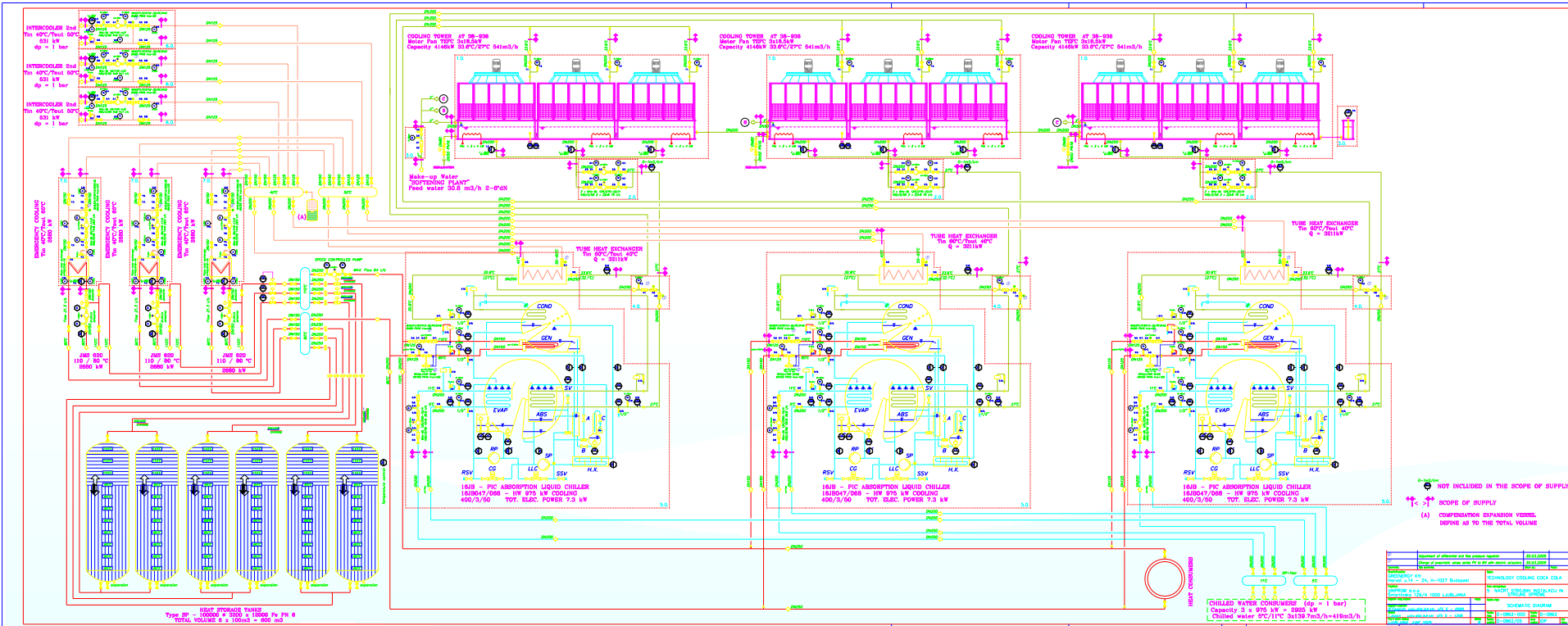

Revizija	Opis promjena	Datum
01	Ukupno izradjeno	02.02.2023.
02	Ukupno izradjeno	02.02.2023.
03	Ukupno izradjeno	02.02.2023.
04	Ukupno izradjeno	02.02.2023.
05	Ukupno izradjeno	02.02.2023.
06	Ukupno izradjeno	02.02.2023.
07	Ukupno izradjeno	02.02.2023.
08	Ukupno izradjeno	02.02.2023.
09	Ukupno izradjeno	02.02.2023.
10	Ukupno izradjeno	02.02.2023.
11	Ukupno izradjeno	02.02.2023.
12	Ukupno izradjeno	02.02.2023.
13	Ukupno izradjeno	02.02.2023.
14	Ukupno izradjeno	02.02.2023.
15	Ukupno izradjeno	02.02.2023.
16	Ukupno izradjeno	02.02.2023.
17	Ukupno izradjeno	02.02.2023.
18	Ukupno izradjeno	02.02.2023.
19	Ukupno izradjeno	02.02.2023.
20	Ukupno izradjeno	02.02.2023.
21	Ukupno izradjeno	02.02.2023.
22	Ukupno izradjeno	02.02.2023.
23	Ukupno izradjeno	02.02.2023.
24	Ukupno izradjeno	02.02.2023.
25	Ukupno izradjeno	02.02.2023.
26	Ukupno izradjeno	02.02.2023.
27	Ukupno izradjeno	02.02.2023.
28	Ukupno izradjeno	02.02.2023.
29	Ukupno izradjeno	02.02.2023.
30	Ukupno izradjeno	02.02.2023.
31	Ukupno izradjeno	02.02.2023.
32	Ukupno izradjeno	02.02.2023.
33	Ukupno izradjeno	02.02.2023.
34	Ukupno izradjeno	02.02.2023.
35	Ukupno izradjeno	02.02.2023.
36	Ukupno izradjeno	02.02.2023.
37	Ukupno izradjeno	02.02.2023.
38	Ukupno izradjeno	02.02.2023.
39	Ukupno izradjeno	02.02.2023.
40	Ukupno izradjeno	02.02.2023.
41	Ukupno izradjeno	02.02.2023.
42	Ukupno izradjeno	02.02.2023.
43	Ukupno izradjeno	02.02.2023.
44	Ukupno izradjeno	02.02.2023.
45	Ukupno izradjeno	02.02.2023.
46	Ukupno izradjeno	02.02.2023.
47	Ukupno izradjeno	02.02.2023.
48	Ukupno izradjeno	02.02.2023.
49	Ukupno izradjeno	02.02.2023.
50	Ukupno izradjeno	02.02.2023.
51	Ukupno izradjeno	02.02.2023.
52	Ukupno izradjeno	02.02.2023.
53	Ukupno izradjeno	02.02.2023.
54	Ukupno izradjeno	02.02.2023.
55	Ukupno izradjeno	02.02.2023.
56	Ukupno izradjeno	02.02.2023.
57	Ukupno izradjeno	02.02.2023.
58	Ukupno izradjeno	02.02.2023.
59	Ukupno izradjeno	02.02.2023.
60	Ukupno izradjeno	02.02.2023.
61	Ukupno izradjeno	02.02.2023.
62	Ukupno izradjeno	02.02.2023.
63	Ukupno izradjeno	02.02.2023.
64	Ukupno izradjeno	02.02.2023.
65	Ukupno izradjeno	02.02.2023.
66	Ukupno izradjeno	02.02.2023.
67	Ukupno izradjeno	02.02.2023.
68	Ukupno izradjeno	02.02.2023.
69	Ukupno izradjeno	02.02.2023.
70	Ukupno izradjeno	02.02.2023.
71	Ukupno izradjeno	02.02.2023.
72	Ukupno izradjeno	02.02.2023.
73	Ukupno izradjeno	02.02.2023.
74	Ukupno izradjeno	02.02.2023.
75	Ukupno izradjeno	02.02.2023.
76	Ukupno izradjeno	02.02.2023.
77	Ukupno izradjeno	02.02.2023.
78	Ukupno izradjeno	02.02.2023.
79	Ukupno izradjeno	02.02.2023.
80	Ukupno izradjeno	02.02.2023.
81	Ukupno izradjeno	02.02.2023.
82	Ukupno izradjeno	02.02.2023.
83	Ukupno izradjeno	02.02.2023.
84	Ukupno izradjeno	02.02.2023.
85	Ukupno izradjeno	02.02.2023.
86	Ukupno izradjeno	02.02.2023.
87	Ukupno izradjeno	02.02.2023.
88	Ukupno izradjeno	02.02.2023.
89	Ukupno izradjeno	02.02.2023.
90	Ukupno izradjeno	02.02.2023.
91	Ukupno izradjeno	02.02.2023.
92	Ukupno izradjeno	02.02.2023.
93	Ukupno izradjeno	02.02.2023.
94	Ukupno izradjeno	02.02.2023.
95	Ukupno izradjeno	02.02.2023.
96	Ukupno izradjeno	02.02.2023.
97	Ukupno izradjeno	02.02.2023.
98	Ukupno izradjeno	02.02.2023.
99	Ukupno izradjeno	02.02.2023.
100	Ukupno izradjeno	02.02.2023.

HEAT ACCUMULATOR

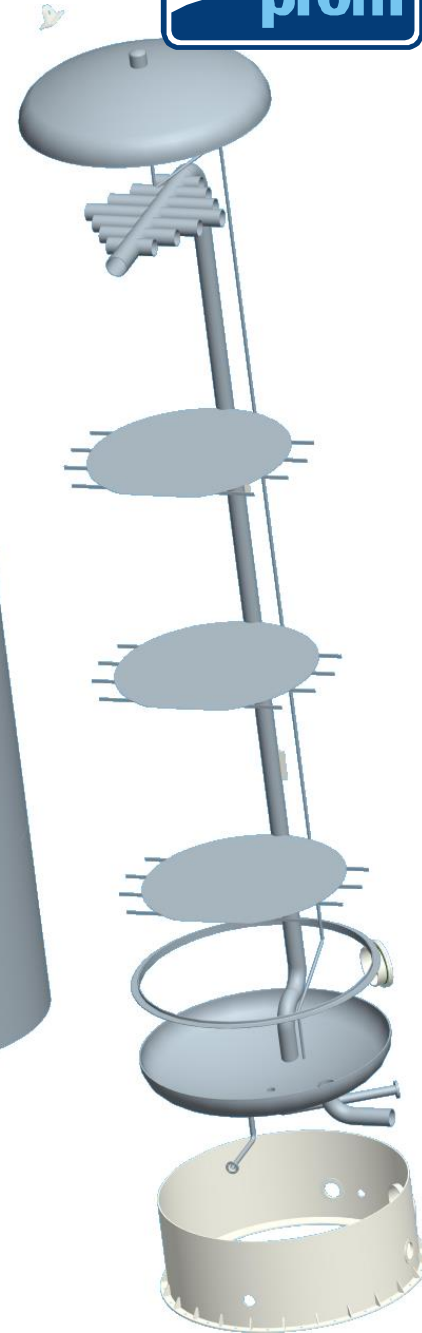
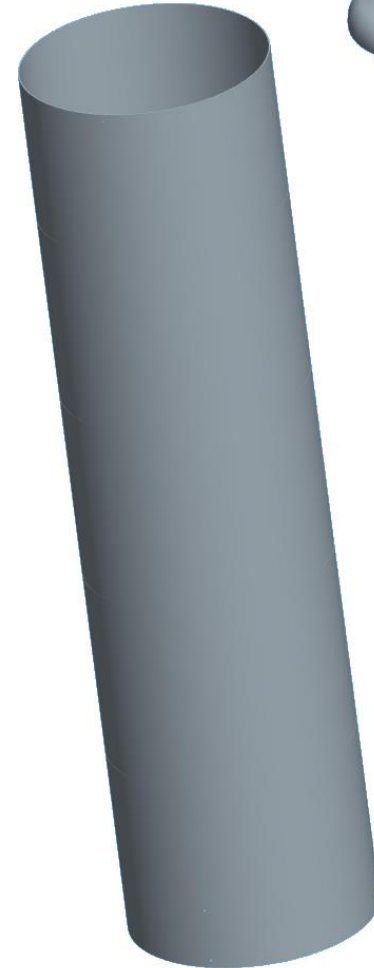
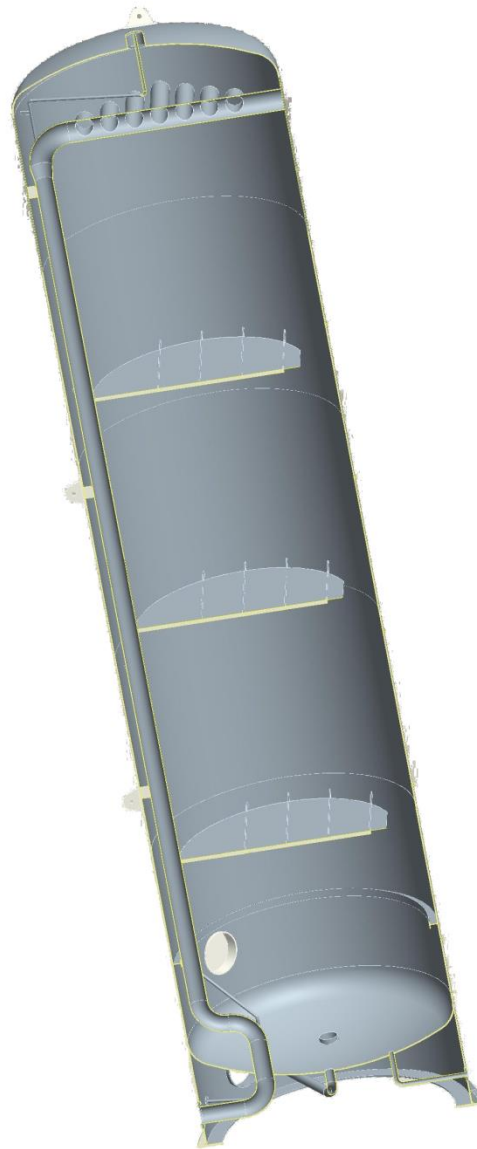
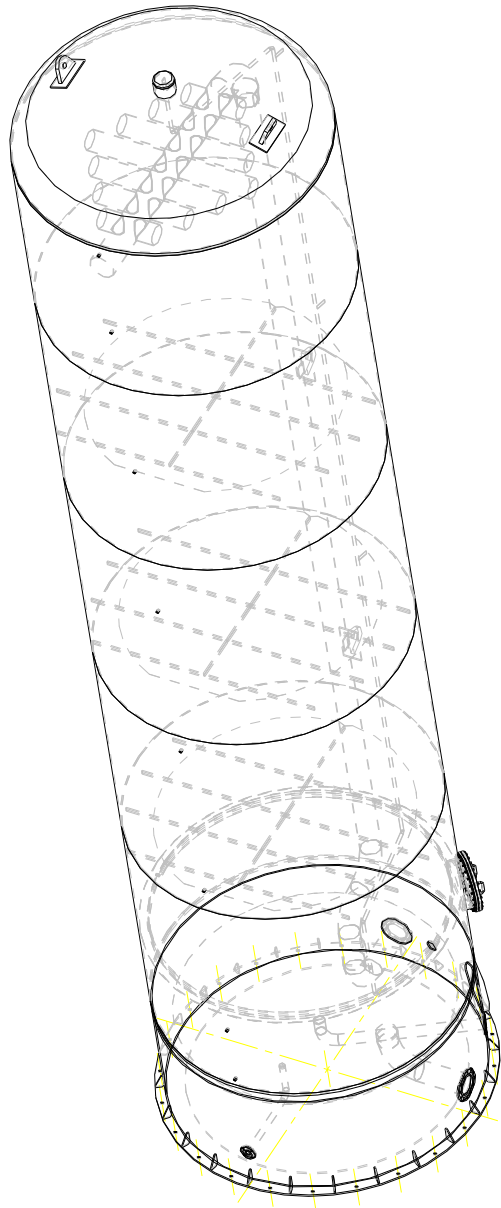

THREE GENERATION ENERGETIC STATION

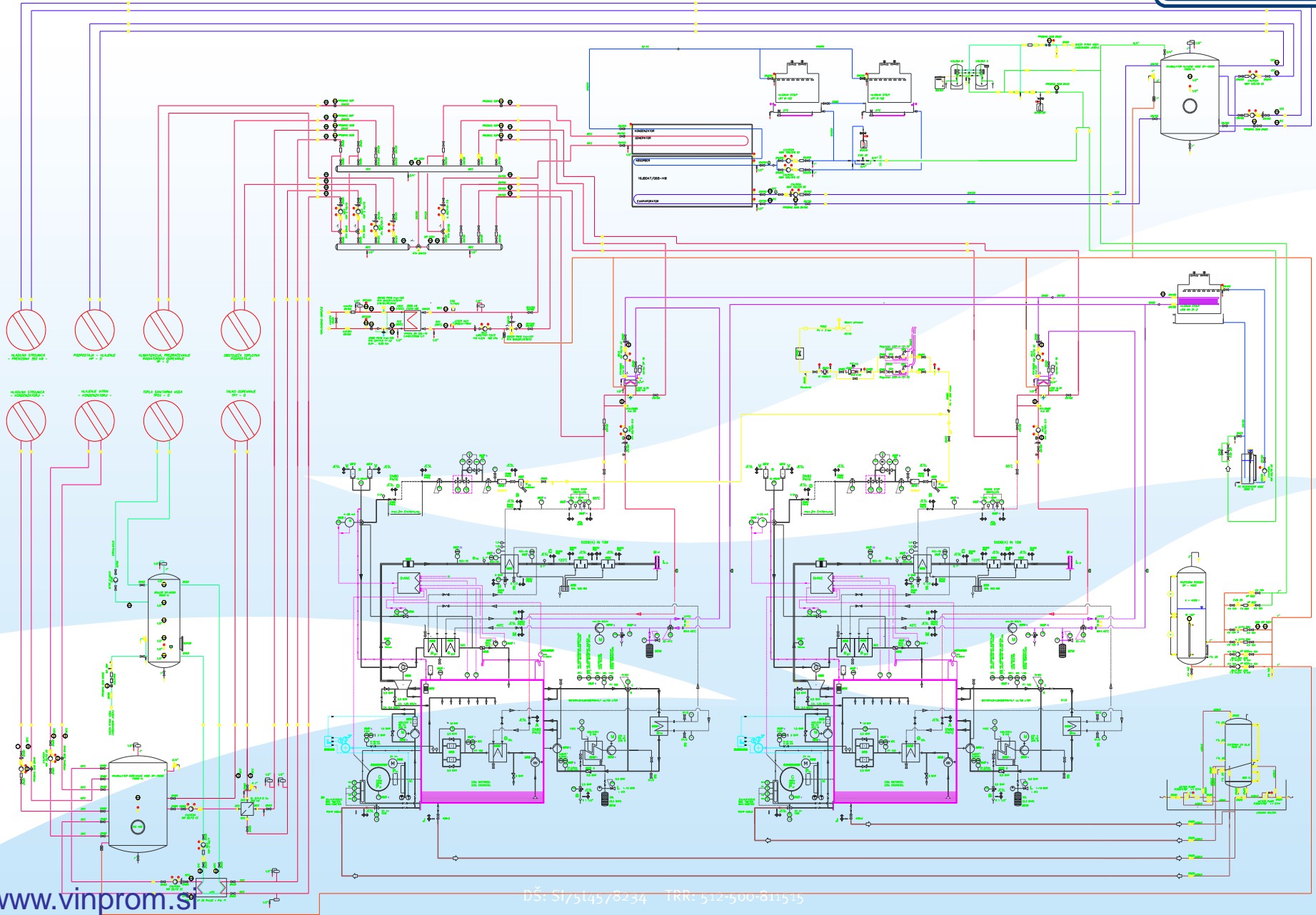

HEATING STATION

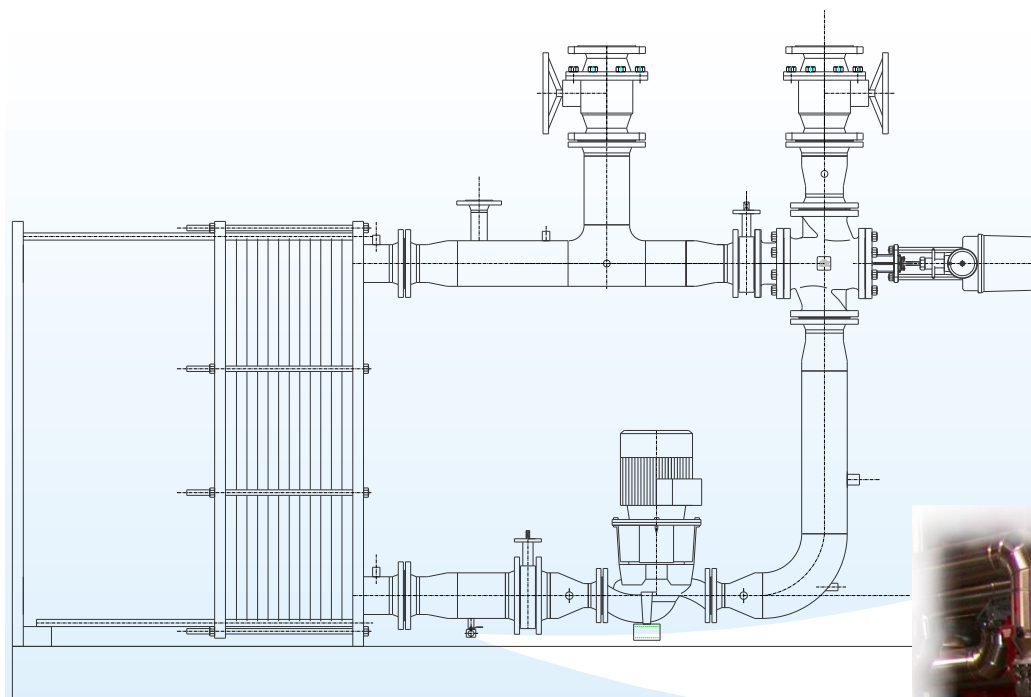

ABSORPTION LIQUID CHILLER

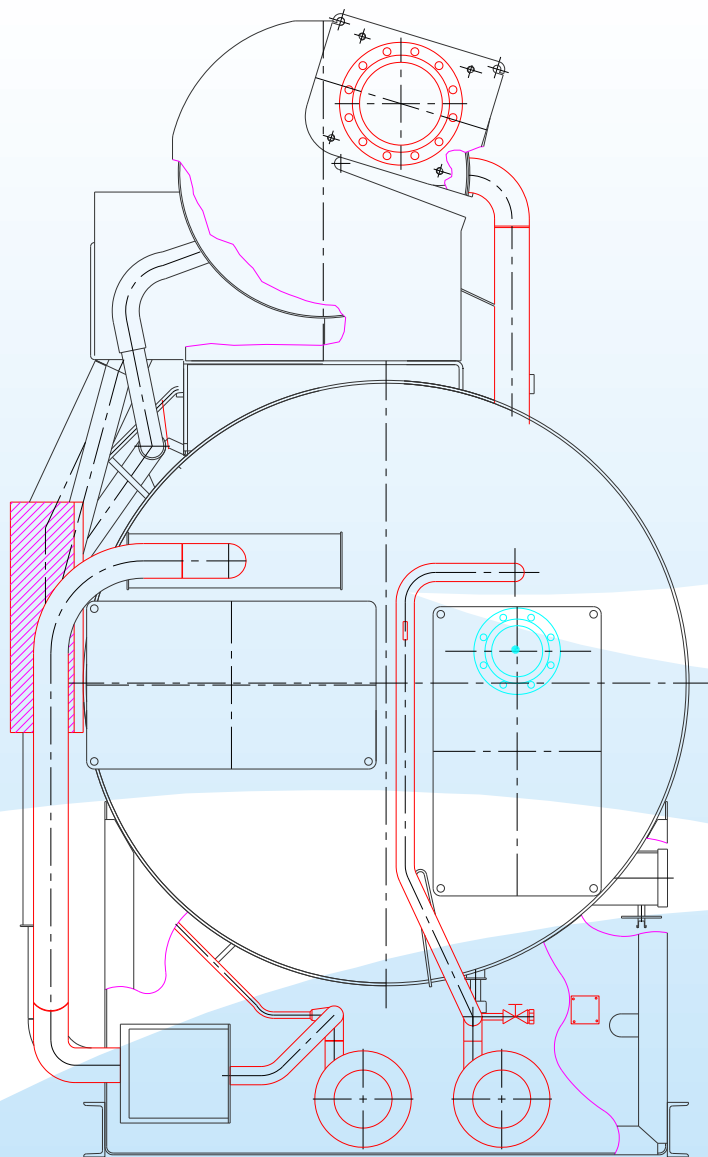

Expansion vessel

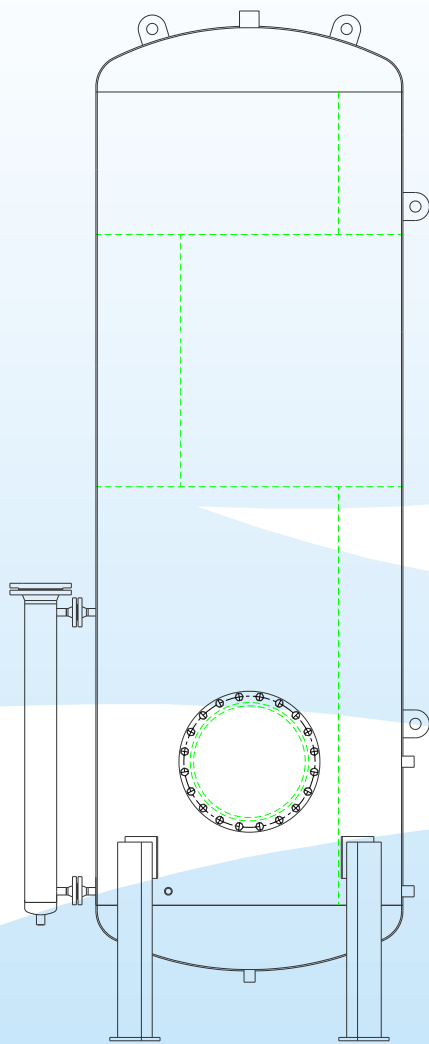

**THANK YOU FOR YOUR
ATTENTION**

